

A-A (2 : 1)

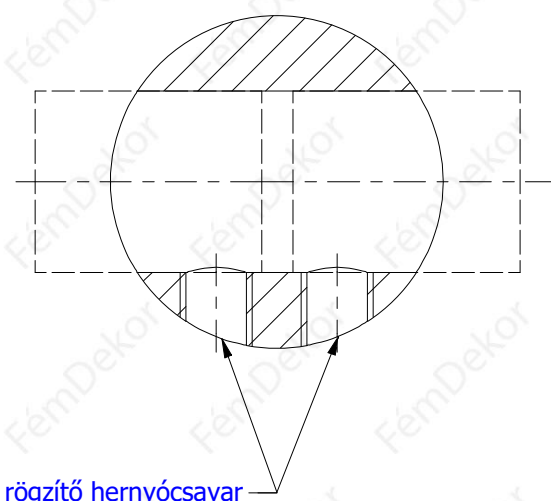

B-B (2 : 1)

